

Istruzioni per la pulizia

Gli articoli FERPLAST sono prodotti di prima qualità realizzati in acciaio inossidabile AISI 304 o AISI 316 che li rende resistenti alla corrosione e all'usura del tempo, altamente igienici, facili da pulire. Al fine di garantire che le superfici mantengano il loro originale aspetto, MAI utilizzare spugne o panni abrasivi né agenti chimici aggressivi per la loro pulizia.

La pulizia dipende dalla finitura.

- Le grate e le cover in acciaio inox si puliscono utilizzando un panno morbido, detergenti neutri e acqua tiepida.
- I vetri d'autore si puliscono con un panno morbido e un prodotto incolore per vetri o acqua tiepida.
- Le grate e cover con finiture oro si puliscono utilizzando un panno morbido e sapone neutro o alcool. MAI utilizzare pagliette o prodotti abrasivi!
- Per le finiture marmorizzate si consiglia l'uso di detergenti neutri per superfici delicate. Evitare interventi meccanici abrasivi.

Garanzia

Gli articoli FERPLAST in acciaio inox con finitura mirror sono garantiti 20 anni. Le finiture metalliche (oro 18kt, ramato, satinato, anticato) e le finiture marmorizzate hanno garanzia triennale. La garanzia è nulla (non ha validità) in caso di manutenzione non corretta. Per reclami, difetti o guasti si prega di contattare direttamente la ditta FERPLAST srl.

Cleaning instructions

FERPLAST floor drains and channels are top quality products manufactured using first class AISI 304 or 316 stainless steel to make them corrosion resistant, highly hygienic as well as long lasting and easy to clean. To ensure that the surface of grates and covers retain their original appearance NEVER use scouring sponges or pads nor aggressive chemical cleaners.

Cleaning depends on the type of finishing

- Stainless steel grates and covers are to be cleaned using a soft cloth, a mild household cleaner and warm water.
- Glass design inserts are to be cleaned using a soft cloth and warm water or a mild colourless glass and window cleaner.
- 18kt gold finishing grates and covers are to be cleaned using a soft cloth and mild soap or alcohol. NO steel scrubbers/pads or harsh chemicals ever!
- For marble finishing the use of a mild floor cleaner is highly recommended. Avoid mechanical abrasive action.

Warranty

All FERPLAST products are made of high-quality stainless steel and carry a 20 years' warranty. Metal (gold, satin, copper, old effect) and marble finishing are guaranteed for 3 years only. The warranty is not valid in case of damage due to improper maintenance. For claims, faults or failures please contact FERPLAST Srl.

Piletta a filo pavimento con sifone in acciaio.
Drain de plancher avec siphon en acier.



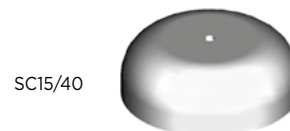
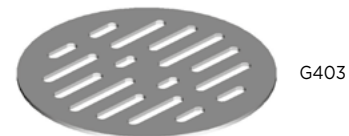
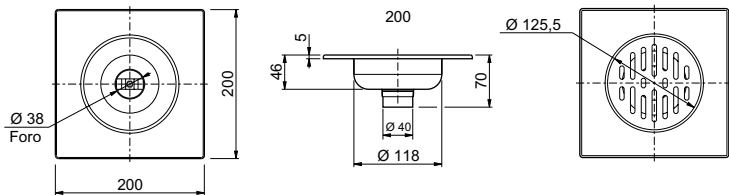
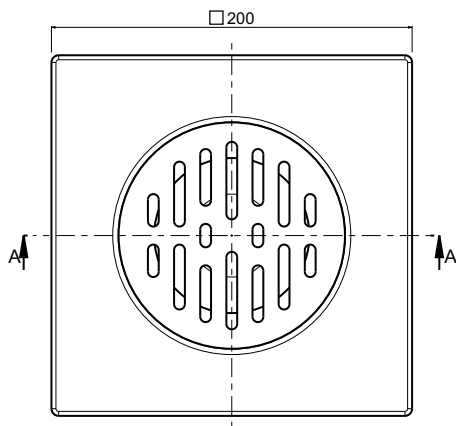
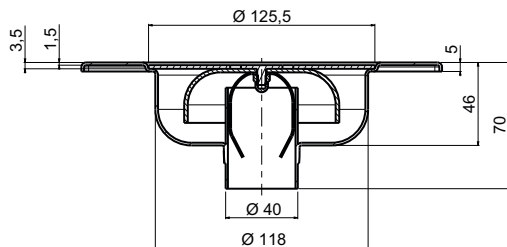

5SCADC

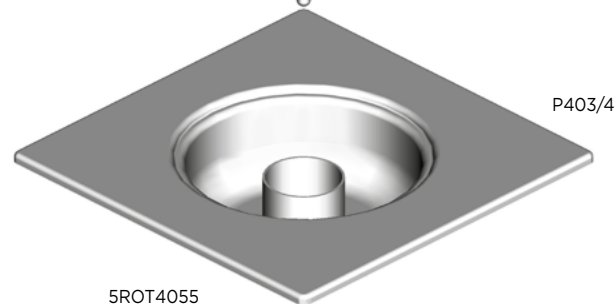

5ROT4055